

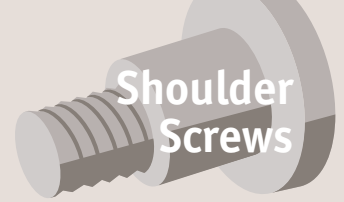

# Product Overview

## Shoulder Screws & Shoulder Bolts



SHOULDER SCREWS

### Steel shoulder screws

These are our least expensive option. They are produced to ISO 7379 standards.

Thread sizes from Ø4 M3 to Ø24 M20. We manufacture special shoulder screws to customer drawings with a minimum batch size.



### Stainless steel shoulder screws

We have three different grades of stainless steel shoulder screws:

**303 series** – these are our standard grade of stainless (P0130.A2). They are strong and resistant to corrosion but not to very harsh environments such as salt water.



**416 series** – these are made from harder stainless steel with improved shear strengths but the parts are more prone to corrosion (see part no. P0131 and P0133).

**316 series** – these shoulder screws (P0130.A4) are very resistant to corrosion but are considerably more expensive than other stainless versions.



### Shoulder bolts

Our range of precision shoulder bolts with hexagonal heads come in both steel (grades 8.8 and 10.9) and stainless steel (303 and 316 stainless). These bolts are manufactured to DIN 609 and DIN 610. We also have shoulder bolts for construction, manufactured to DIN 7968.

	DIN 609 standard length thread	DIN 610 short length thread	DIN 7968 construction thread
<b>Grade 8.8 steel</b> 	P0138.SC	P0140.SC	P0142
<b>Grade 10.9 steel</b> 	P0139	P0141	-
<b>303 stainless steel</b> 	P0138.A2	P0140.A2	-

ov-shoulder-screws-product-overview-a-rmh - Updated 17-02-2023



# Shoulder Screw from Automation Components

Part No.		Material	Head	Corrosion resistance	Strength	Ø/thread	DIN/ISO
P0130		303 stainless steel	Hex socket	✓✓	✓	Min: Ø4/M3 Max: Ø20/M16	-
P0130.A4		316 stainless steel	Hex socket	✓✓✓	✓	Min: Ø4/M3 Max: Ø20/M16	ISO 7379
P0131		416 stainless steel	Hex socket	✓	✓✓	Min: Ø4/M3 Max: Ø12/M10	-
P0132		303 stainless steel	Slotted	✓✓	✓	Min: Ø4/M3 Max: Ø12/M10	-
P0133		416 stainless steel	Slotted	✓	✓✓	Min: Ø4/M3 Max: Ø12/M10	-
P0134		303 stainless steel	Hex socket	✓✓	✓	Min: Ø4/M3 Max: Ø8/M6	-
P0135		303 stainless steel	Hex head	✓✓	✓	Min: Ø4/M3 Max: Ø12/M10	-
P0136		Steel 12,9	Hex socket	✗	✓✓	Min: Ø4/M3 Max: Ø24/M20	ISO 7379
P0137		304 stainless steel	Hex socket	✓✓	✓	Min: Ø6/M5 Max: Ø20/M16	ISO 7379
P0138		Steel 8,8	Hex head (long thread)	✗	✓	Min: Ø9/M8 Max: Ø44/M42	DIN 610
P0139		Steel 10,9	Hex head (long thread)	✗	✓✓	Min: Ø9/M8 Max: Ø38/M36	DIN 610
P0140		Steel 8,8	Hex socket (short thread)	✗	✓✓	Min: Ø9/M8 Max: Ø44/M42	DIN 609
P0141		Steel 10,9	Hex socket (short thread)	✗	✓✓	Min: Ø9/M8 Max: Ø38/M36	DIN 609
P0142		Steel 8,8	Hex head	✗	✓✓	Min: Ø12/M12 Max: Ø27/M27	DIN 7968
P0144		303 stainless steel	Pan head	✓✓	✓✓	Min: Ø4/M3 Max: Ø10/M8	DIN 923



# Pan Head Shoulder Screws

steel, zinc-plated

## Shoulder Screws

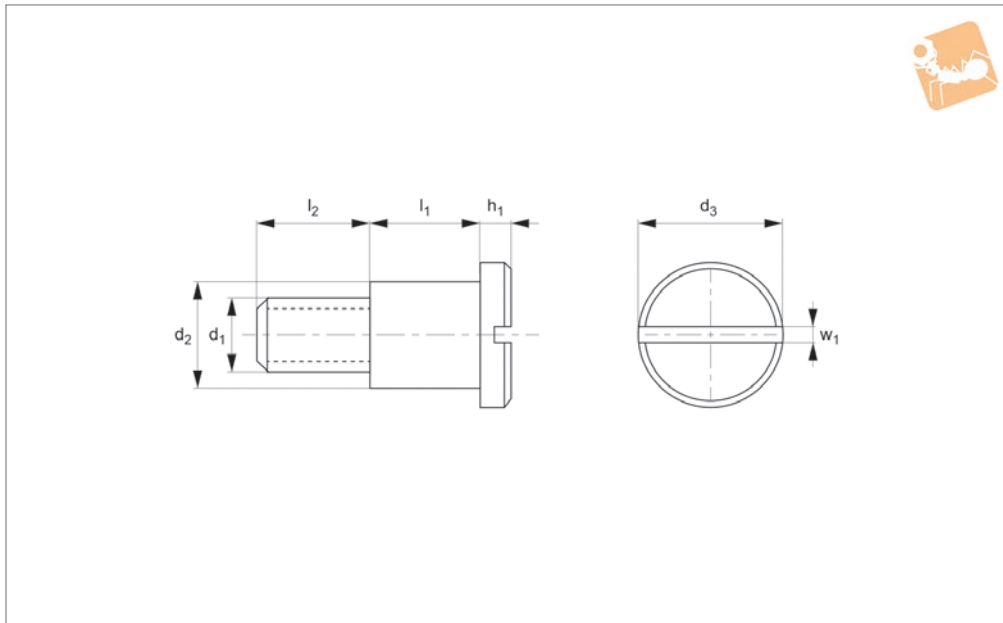

**P0144.ZP**

SHOULDER SCREWS

### Material

Steel, zinc-plated.

### Technical Notes

To DIN 923.

Order No.	d <sub>1</sub>	l <sub>1</sub>	d <sub>2</sub> tol. h9	d <sub>3</sub>	h <sub>1</sub>	l <sub>2</sub>	w <sub>1</sub>
P0144.020-002-ZP	M 2	2	2.8	4.5	1.2	3.0	0.5
P0144.020-003-ZP	M 2	3	2.8	4.5	1.2	3.0	0.5
P0144.020-004-ZP	M 2	4	2.8	4.5	1.2	3.0	0.5
P0144.020-005-ZP	M 2	5	2.8	4.5	1.2	3.0	0.5
P0144.020-006-ZP	M 2	6	2.8	4.5	1.2	3.0	0.5
P0144.020-008-ZP	M 2	8	2.8	4.5	1.2	3.0	0.5
P0144.020-012-ZP	M 2	12	2.8	4.5	1.2	3.0	0.5
P0144.025-003-ZP	M2,5	3	2.8	4.5	1.2	3.0	0.5
P0144.025-004-ZP	M2,5	4	2.8	4.5	1.2	3.0	0.5
P0144.025-005-ZP	M2,5	5	2.8	4.5	1.2	3.0	0.5
P0144.025-006-ZP	M2,5	6	2.8	4.5	1.2	3.0	0.5
P0144.025-008-ZP	M2,5	8	2.8	4.5	1.2	3.0	0.5
P0144.030-001-ZP	M 3	1	4.0	7.0	1.8	4.5	0.8
P0144.030-002-ZP	M 3	2	4.0	7.0	1.8	4.5	0.8
P0144.030-003-ZP	M 3	3	4.0	7.0	1.8	4.5	0.8
P0144.030-004-ZP	M 3	4	4.0	7.0	1.8	4.5	0.8
P0144.030-005-ZP	M 3	5	4.0	7.0	1.8	4.5	0.8
P0144.030-006-ZP	M 3	6	4.0	7.0	1.8	4.5	0.8
P0144.030-008-ZP	M 3	8	4.0	7.0	1.8	4.5	0.8
P0144.030-010-ZP	M 3	10	4.0	7.0	1.8	4.5	0.8
P0144.030-012-ZP	M 3	12	4.0	7.0	1.8	4.5	0.8
P0144.030-016-ZP	M 3	16	4.0	7.0	1.8	4.5	0.8
P0144.030-030-ZP	M 3	30	4.0	7.0	1.8	4.5	0.8
P0144.040-002-ZP	M 4	2	5.5	8.5	2.4	6.0	1.0
P0144.040-003-ZP	M 4	3	5.5	8.5	2.4	6.0	1.0
P0144.040-004-ZP	M 4	4	5.5	8.5	2.4	6.0	1.0
P0144.040-005-ZP	M 4	5	5.5	8.5	2.4	6.0	1.0
P0144.040-006-ZP	M 4	6	5.5	8.5	2.4	6.0	1.0
P0144.040-008-ZP	M 4	8	5.5	8.5	2.4	6.0	1.0
P0144.040-010-ZP	M 4	10	5.5	8.5	2.4	6.0	1.0
P0144.040-012-ZP	M 4	12	5.5	8.5	2.4	6.0	1.0
P0144.040-016-ZP	M 4	16	5.5	8.5	2.4	6.0	1.0
P0144.040-020-ZP	M 4	20	5.5	8.5	2.4	6.0	1.0
P0144.040-030-ZP	M 4	30	5.5	8.5	2.4	6.0	1.0

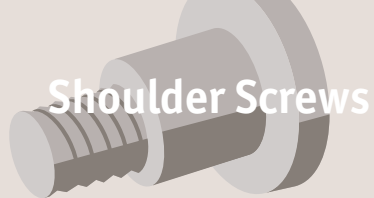

# Shoulder Screws

## Pan Head Shoulder Screws steel, zinc-plated



SHOULDER SCREWS

Order No.	d <sub>1</sub>	l <sub>1</sub>	d <sub>2</sub> tol. h9	d <sub>3</sub>	h <sub>1</sub>	l <sub>2</sub>	w <sub>1</sub>
P0144.050-002-ZP	M 5	2	7.0	11.0	2.7	7.0	1.2
P0144.050-003-ZP	M 5	3	7.0	11.0	2.7	7.0	1.2
P0144.050-004-ZP	M 5	4	7.0	11.0	2.7	7.0	1.2
P0144.050-005-ZP	M 5	5	7.0	11.0	2.7	7.0	1.2
P0144.050-006-ZP	M 5	6	7.0	11.0	2.7	7.0	1.2
P0144.050-008-ZP	M 5	8	7.0	11.0	2.7	7.0	1.2
P0144.050-010-ZP	M 5	10	7.0	11.0	2.7	7.0	1.2
P0144.050-012-ZP	M 5	12	7.0	11.0	2.7	7.0	1.2
P0144.050-016-ZP	M 5	16	7.0	11.0	2.7	7.0	1.2
P0144.050-020-ZP	M 5	20	7.0	11.0	2.7	7.0	1.2
P0144.050-025-ZP	M 5	25	7.0	11.0	2.7	7.0	1.2
P0144.060-002-ZP	M 6	2	8.0	13.0	3.1	9.0	1.6
P0144.060-003-ZP	M 6	3	8.0	13.0	3.1	9.0	1.6
P0144.060-004-ZP	M 6	4	8.0	13.0	3.1	9.0	1.6
P0144.060-005-ZP	M 6	5	8.0	13.0	3.1	9.0	1.6
P0144.060-006-ZP	M 6	6	8.0	13.0	3.1	9.0	1.6
P0144.060-008-ZP	M 6	8	8.0	13.0	3.1	9.0	1.6
P0144.060-010-ZP	M 6	10	8.0	13.0	3.1	9.0	1.6
P0144.060-012-ZP	M 6	12	8.0	13.0	3.1	9.0	1.6
P0144.060-016-ZP	M 6	16	8.0	13.0	3.1	9.0	1.6
P0144.060-020-ZP	M 6	16	8.0	13.0	3.1	9.0	1.6
P0144.060-025-ZP	M 6	25	8.0	13.0	3.1	9.0	1.6
P0144.080-004-ZP	M 8	4	10.0	16.0	3.8	11.0	2.0
P0144.080-005-ZP	M 8	5	10.0	16.0	3.8	11.0	2.0
P0144.080-006-ZP	M 8	6	10.0	16.0	3.8	11.0	2.0
P0144.080-008-ZP	M 8	8	10.0	16.0	3.8	11.0	2.0
P0144.080-010-ZP	M 8	10	10.0	16.0	3.8	11.0	2.0
P0144.080-012-ZP	M 8	12	10.0	16.0	3.8	11.0	2.0
P0144.080-016-ZP	M 8	16	10.0	16.0	3.8	11.0	2.0
P0144.080-020-ZP	M 8	20	10.0	16.0	3.8	11.0	2.0
P0144.080-025-ZP	M 8	25	10.0	16.0	3.8	11.0	2.0
P0144.100-005-ZP	M10	5	13.0	20.0	4.6	13.5	2.5
P0144.100-006-ZP	M10	6	13.0	20.0	4.6	13.5	2.5
P0144.100-008-ZP	M10	8	13.0	20.0	4.6	13.5	2.5
P0144.100-010-ZP	M10	10	13.0	20.0	4.6	13.5	2.5
P0144.100-012-ZP	M10	12	13.0	20.0	4.6	13.5	2.5
P0144.100-016-ZP	M10	16	13.0	20.0	4.6	13.5	2.5
P0144.100-020-ZP	M10	20	13.0	20.0	4.6	13.5	2.5
P0144.100-025-ZP	M10	25	13.0	20.0	4.6	13.5	2.5



# Shoulder Screws - Hex. Socket Head

steel- blackened

# Shoulder Screws

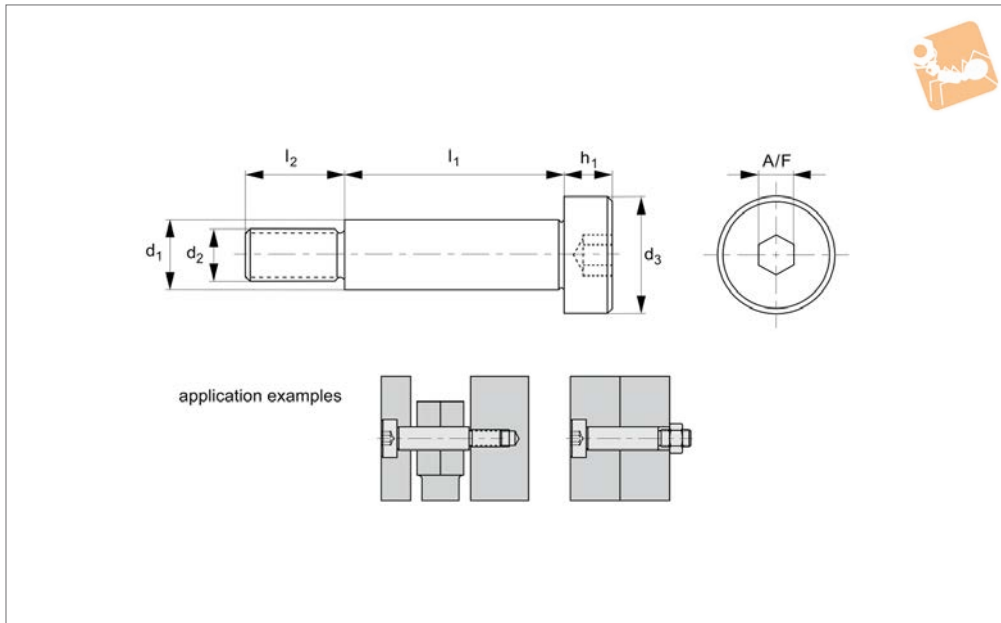

**P0136**

SHOULDER SCREWS

**Material**

Blackened alloy steel, high grade strength 012,9.  
Hardness 38 HRC, tensile strength 1200 N/mm<sup>2</sup>.

+300°C.

**Tips**

Torque to:  
M5 = 7,5 Nm. M6 = 13 Nm. M8 = 33 Nm.  
M10 = 60 Nm. M12 = 120 Nm. M16 = 270 Nm.

**Technical Notes**

To ISO 7379. Temperature range -50°C to

Order No.	d <sub>1</sub> tol. f9	l <sub>1</sub> +0,25	d <sub>2</sub>	d <sub>3</sub>	h <sub>1</sub>	l <sub>2</sub>	A/F
P0136.040-005	4	5	M 3	7	3	7	2
P0136.040-008	4	8	M 3	7	3	7	2
P0136.040-010	4	10	M 3	7	3	7	2
P0136.040-012	4	12	M 3	7	3	7	2
P0136.040-016	4	16	M 3	7	3	7	2
P0136.040-020	4	20	M 3	7	3	7	2
P0136.040-025	4	25	M 3	7	3	7	2
P0136.040-030	4	30	M 3	7	3	7	2
P0136.050-006	5	6	M 4	9	4	8	2.5
P0136.050-008	5	8	M 4	9	4	8	2.5
P0136.050-010	5	10	M 4	9	4	8	2.5
P0136.050-012	5	12	M 4	9	4	8	2.5
P0136.050-016	5	16	M 4	9	4	8	2.5
P0136.050-020	5	20	M 4	9	4	8	2.5
P0136.050-025	5	25	M 4	9	4	8	2.5
P0136.050-030	5	30	M 4	9	4	8	2.5
P0136.060-006	6	6	M 5	10	4.5	9.5	3
P0136.060-008	6	8	M 5	10	4.5	9.5	3
P0136.060-010	6	10	M 5	10	4.5	9.5	3
P0136.060-012	6	12	M 5	10	4.5	9.5	3
P0136.060-016	6	16	M 5	10	4.5	9.5	3
P0136.060-020	6	20	M 5	10	4.5	9.5	3
P0136.060-025	6	25	M 5	10	4.5	9.5	3
P0136.060-030	6	30	M 5	10	4.5	9.5	3
P0136.060-035	6	35	M 5	10	4.5	9.5	3
P0136.060-040	6	40	M 5	10	4.5	9.5	3
P0136.060-045	6	45	M 5	10	4.5	9.5	3
P0136.060-050	6	50	M 5	10	4.5	9.5	3
P0136.060-055	6	55	M 5	10	4.5	9.5	3
P0136.060-060	6	60	M 5	10	4.5	9.5	3

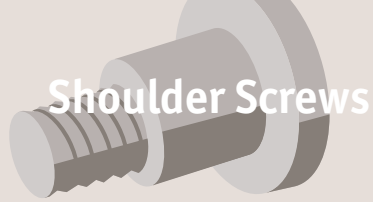

# Shoulder Screws

## Shoulder Screws - Hex. Socket Head steel- blackened



SHOULDER SCREWS

Order No.	d <sub>1</sub> tol. f9	l <sub>1</sub> +0.25	d <sub>2</sub>	d <sub>3</sub>	h <sub>1</sub>	l <sub>2</sub>	A/F
P0136.060-065	6	65	M 5	10	4.5	9.5	3
P0136.060-070	6	70	M 5	10	4.5	9.5	3
P0136.060-075	6	75	M 5	10	4.5	9.5	3
P0136.060-080	6	80	M 5	10	4.5	9.5	3
P0136.060-090	6	90	M 5	10	4.5	9.5	3
P0136.060-100	6	100	M 5	10	4.5	9.5	3
P0136.080-008	8	8	M 6	13	5.5	11	4
P0136.080-010	8	10	M 6	13	5.5	11	4
P0136.080-012	8	12	M 6	13	5.5	11	4
P0136.080-016	8	16	M 6	13	5.5	11	4
P0136.080-020	8	20	M 6	13	5.5	11	4
P0136.080-025	8	25	M 6	13	5.5	11	4
P0136.080-030	8	30	M 6	13	5.5	11	4
P0136.080-035	8	35	M 6	13	5.5	11	4
P0136.080-040	8	40	M 6	13	5.5	11	4
P0136.080-045	8	45	M 6	13	5.5	11	4
P0136.080-050	8	50	M 6	13	5.5	11	4
P0136.080-055	8	55	M 6	13	5.5	11	4
P0136.080-060	8	60	M 6	13	5.5	11	4
P0136.080-065	8	65	M 6	13	5.5	11	4
P0136.080-070	8	70	M 6	13	5.5	11	4
P0136.080-075	8	75	M 6	13	5.5	11	4
P0136.080-080	8	80	M 6	13	5.5	11	4
P0136.080-090	8	90	M 6	13	5.5	11	4
P0136.080-100	8	100	M 6	13	5.5	11	4
P0136.100-010	10	10	M 8	16	7	13	5
P0136.100-012	10	12	M 8	16	7	13	5
P0136.100-016	10	16	M 8	16	7	13	5
P0136.100-020	10	20	M 8	16	7	13	5
P0136.100-025	10	25	M 8	16	7	13	5
P0136.100-030	10	30	M 8	16	7	13	5
P0136.100-035	10	35	M 8	16	7	13	5
P0136.100-040	10	40	M 8	16	7	13	5
P0136.100-045	10	45	M 8	16	7	13	5
P0136.100-050	10	50	M 8	16	7	13	5
P0136.100-055	10	55	M 8	16	7	13	5
P0136.100-060	10	60	M 8	16	7	13	5
P0136.100-065	10	65	M 8	16	7	13	5
P0136.100-070	10	70	M 8	16	7	13	5
P0136.100-075	10	75	M 8	16	7	13	5
P0136.100-080	10	80	M 8	16	7	13	5
P0136.100-090	10	90	M 8	16	7	13	5
P0136.100-100	10	100	M 8	16	7	13	5
P0136.100-120	10	120	M 8	16	7	13	5
P0136.120-012	12	12	M10	18	9	16	6
P0136.120-016	12	16	M10	18	9	16	6
P0136.120-020	12	20	M10	18	9	16	6
P0136.120-025	12	25	M10	18	9	16	6
P0136.120-030	12	30	M10	18	9	16	6
P0136.120-035	12	35	M10	18	9	16	6
P0136.120-040	12	40	M10	18	9	16	6
P0136.120-045	12	45	M10	18	9	16	6
P0136.120-050	12	50	M10	18	9	16	6
P0136.120-055	12	55	M10	18	9	16	6
P0136.120-060	12	60	M10	18	9	16	6
P0136.120-065	12	65	M10	18	9	16	6
P0136.120-070	12	70	M10	18	9	16	6
P0136.120-075	12	75	M10	18	9	16	6
P0136.120-080	12	80	M10	18	9	16	6
P0136.120-090	12	90	M10	18	9	16	6
P0136.120-100	12	100	M10	18	9	16	6
P0136.120-110	12	110	M10	18	9	16	6
P0136.160-020	16	20	M12	24	11	18	8
P0136.160-025	16	25	M12	24	11	18	8
P0136.160-030	16	30	M12	24	11	18	8
P0136.160-035	16	35	M12	24	11	18	8
P0136.160-040	16	40	M12	24	11	18	8
P0136.160-045	16	45	M12	24	11	18	8



# Shoulder Screws - Hex. Socket Head

steel- blackened

## Shoulder Screws



Order No.	d <sub>1</sub> tol. ±9	l <sub>1</sub> +0.25	d <sub>2</sub>	d <sub>3</sub>	h <sub>1</sub>	l <sub>2</sub>	A/F
P0136.160-050	16	50	M12	24	11	18	8
P0136.160-055	16	55	M12	24	11	18	8
P0136.160-060	16	60	M12	24	11	18	8
P0136.160-065	16	65	M12	24	11	18	8
P0136.160-070	16	70	M12	24	11	18	8
P0136.160-075	16	75	M12	24	11	18	8
P0136.160-080	16	80	M12	24	11	18	8
P0136.160-090	16	90	M12	24	11	18	8
P0136.160-100	16	100	M12	24	11	18	8
P0136.160-120	16	120	M12	24	11	18	8
P0136.200-020	20	20	M16	30	14	22	10
P0136.200-025	20	25	M16	30	14	22	10
P0136.200-030	20	30	M16	30	14	22	10
P0136.200-035	20	35	M16	30	14	22	10
P0136.200-040	20	40	M16	30	14	22	10
P0136.200-045	20	45	M16	30	14	22	10
P0136.200-050	20	50	M16	30	14	22	10
P0136.200-055	20	55	M16	30	14	22	10
P0136.200-060	20	60	M16	30	14	22	10
P0136.200-065	20	65	M16	30	14	22	10
P0136.200-070	20	70	M16	30	14	22	10
P0136.200-075	20	75	M16	30	14	22	10
P0136.200-080	20	80	M16	30	14	22	10
P0136.200-090	20	90	M16	30	14	22	10
P0136.200-100	20	100	M16	30	14	22	10
P0136.200-120	20	120	M16	30	14	22	10
P0136.240-020	24	20	M20	36	16	27	12
P0136.240-025	24	25	M20	36	16	27	12
P0136.240-030	24	30	M20	36	16	27	12
P0136.240-035	24	35	M20	36	16	27	12
P0136.240-040	24	40	M20	36	16	27	12
P0136.240-045	24	45	M20	36	16	27	12
P0136.240-050	24	50	M20	36	16	27	12
P0136.240-055	24	55	M20	36	16	27	12
P0136.240-060	24	60	M20	36	16	27	12
P0136.240-065	24	65	M20	36	16	27	12
P0136.240-070	24	70	M20	36	16	27	12
P0136.240-075	24	75	M20	36	16	27	12
P0136.240-080	24	80	M20	36	16	27	12
P0136.240-090	24	90	M20	36	16	27	12
P0136.240-100	24	100	M20	36	16	27	12
P0136.240-120	24	120	M20	36	16	27	12

SHOULDER SCREWS