

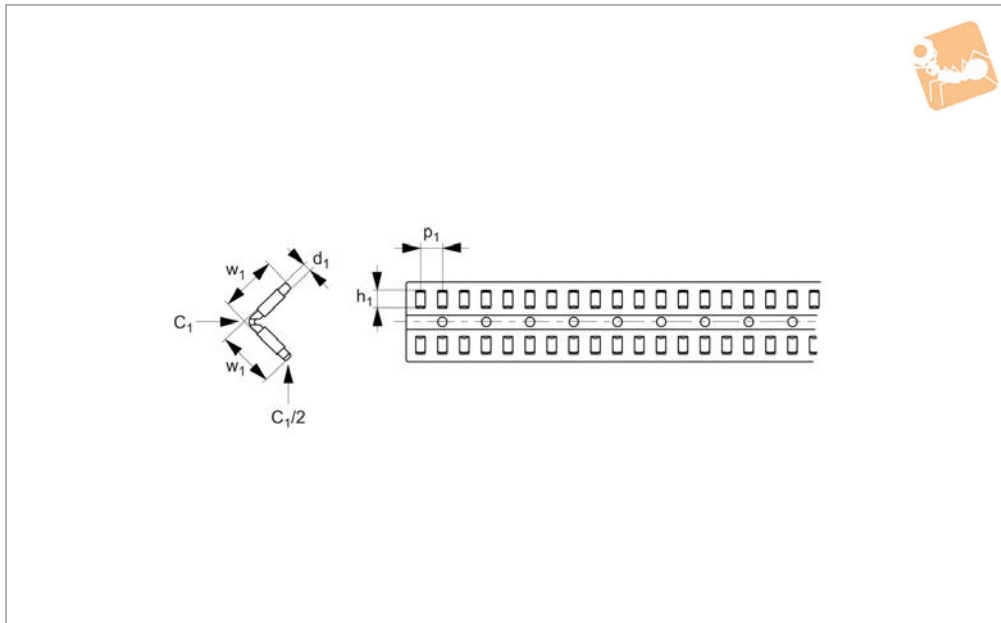

Needle Roller Linear Cages

Ball & Needle Cages



L1004.HW

BALL & NEEDLE CAGES

Material

Steel rollers (100Cr6, hardened to 60 HRC), aluminium retaining cage (apart from L1004.HW10 - steel).

Technical Notes

When ordering please specify the length

required (must be a multiple of pitch, p).
 Supplied in max. 1 metre lengths.
 Ordering example:
 L1004.HW15-030 is a 3mm diameter roller strip 45mm long with 30 rollers (as 10xp = 45mm).

Tips

See technical pages for load rating calculations - based on rail size and number of rollers in the system cages.

Order No.	d_1 ± 0.001	p_1	h_1	w_1	Dyn. load C /pair of rollers N max.	To suit rail
L1004.HW10-xxx	2.0	4.0	4.8	10	2.500	L1004.22
L1004.HW15-xxx	2.0	4.5	6.8	15	4.000	L1004.25
L1004.HW20xxx	2.5	5.5	9.8	20	7.300	L1004.30
L1004.HW25-xxx	3.0	6.0	13.8	25	12.500	L1004.35
L1004.HW30-xxx	3.5	7.0	17.8	30	18.500	L1004.45

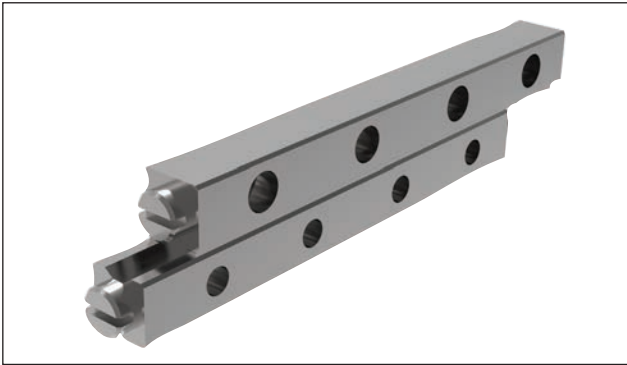

Standard cross roller rail sets

L1000 & L1001

- Seven rail profiles (Sizes 1-12)
- Lengths: 20mm to 1 metre
- L1000 standard rail set
- L1001 corrosion resistant rail sets

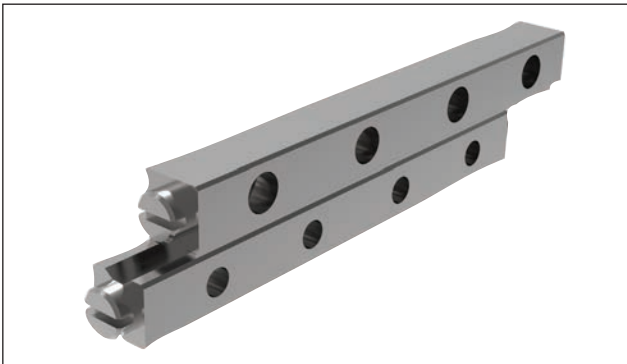

Deep groove and anti-creep rail sets

L1002 + L1003

- 3 x load capacity of standard rail sets (due to deep V groove)
- Two rail profiles (Sizes 4 & 6)
- Lengths 50mm to 400mm
- Anti-creep versions for high acceleration applications



Needle roller rail sets

L1004

- Heavy load ratings and needle rollers are used
- Five rail profile size
- Lengths: 200mm to 1.2 metres

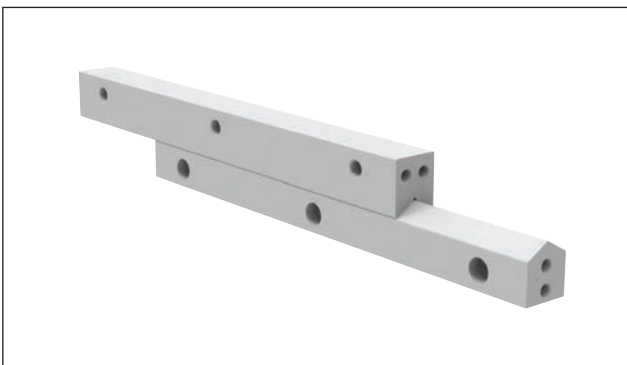

Anti-friction coated rail sets

L1005 & L1006

- Same profile as needle roller rails but contact face Teflon coated.
- Ideal for harsh, dirty conditions
- Vibration damping characteristics



Our cross roller rail sets are of the highest quality.

- Close tolerance $\pm 5\mu$
- Speeds up to 50 m/min
- Temperature range -40°C to $+80^{\circ}\text{C}$ up to $+250^{\circ}\text{C}$ if applying a temperature factor
- Through hardened to 60 ± 2 HRC
- Acceleration up to 50 m/sec^2
- Typical 0.003 coefficient of friction dependent on mounting surface accuracy

Expected life calculation:

$$\text{Life (Km)} L = (C/P)^{3.3} \times 1.15 \times 10^5 \text{m}$$

C = effective dynamic load (N)

P = equivalent load (N)

Accuracy Specification:

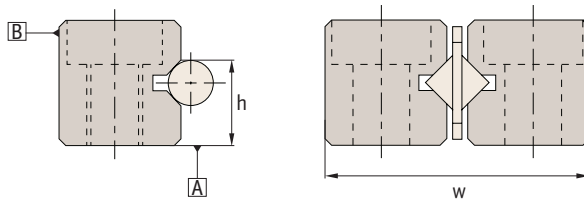

Accuracy level	
Parallelism of rolling plane A&B	graph below
Allowable height tolerance (h)	$\pm 0,02$
Paired mutual height tolerance (h)	0,01
Allowable width tolerance (w)	$+0, -0,02$

Parallelism

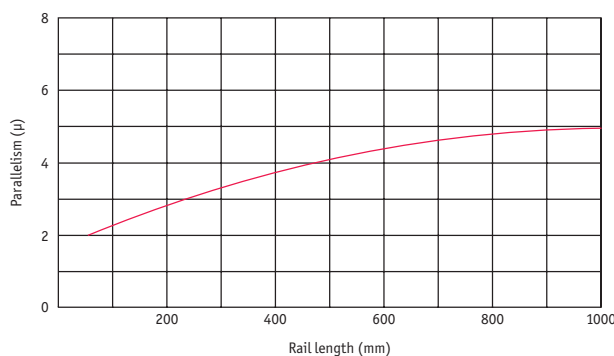

Lubrication:

The units are lubricated with lithium soap lubricant. Relubricate if required.

Working life calculation:

$$L_h \text{ (hours)} = \frac{L \times 10^6}{2 \times L_s \times n \times 60}$$

L = Life (Km), see above

L_s = Stroke Length (mm)

n = Number of operations/min

Straightness		
Length (mm)		Straightness (μ)
Above	Below	
0	50	2,0
50	100	2,0
100	160	3,0
160	310	3,0
310	510	4,0
510	600	4,0

(Ra 0,2 μm)



Load capacity depends on:

- Rail size
- Number of rollers in cage
- Load rating = number of rollers x load rating/roller
- Number of rollers (N_r) = cage length (L_c) / pitch p
- Cage length affects the stroke and travel of the system

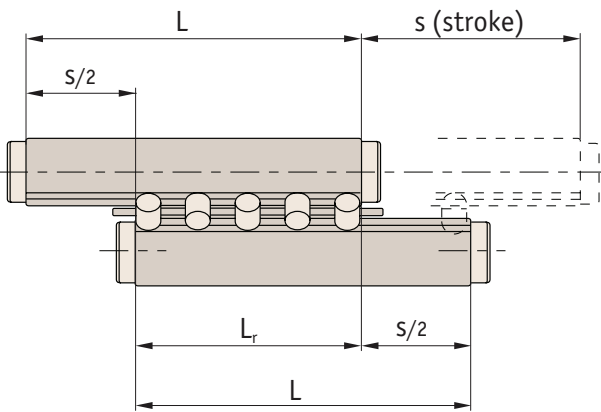

Load calculations

Calculations of retainer length and number of rollers:

$$L_r = \frac{L - S}{2}$$

L_r = distance between two rollers in ends of retainer (mm)

L = rail length (mm)

S = stroke length (mm)

Worked example:

Assume L1000.09-400 with a stroke of 250mm:

Cage length = $400 - (250/2) = 275\text{mm}$

Roller $\varnothing = 9\text{mm}$ with a pitch (see table) of 18mm:

Number of rollers = $275/18 = 15$

Load rating of system = load/roller* x no. of rollers

(a pair of rollers) = $2420\text{N} \times 15$

= 36,300N

*See product table for allowable load per roller.

Allowable load rating with a 3x safety factor compared to static load.

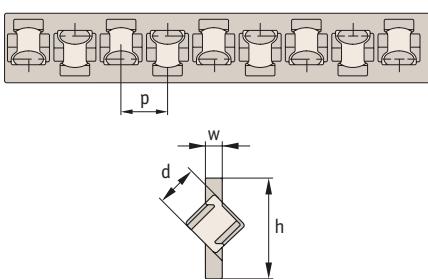

Plastic cage



L1008.###-PR-xxx

Plastic cage with steel rollers,
for horizontal and vertical use.

Steel cage



L1008.###-AA-xxx

Steel cage with steel rollers,
for horizontal use only.

Order no.	d	p	h	w	Cage material
L1008.020-PR-xxx	2	3,9	5	0,75	Plastic - black
L1008.030-PR-xxx	3	5,0	7	1,00	Plastic - black
L1008.060-PR-xxx	6	8,5	14	2,00	Plastic - black
L1008.090-PR-xxx	9	14,0	20	3,00	Plastic - black
L1008.020-AA-xxx	2	4	5,5	0,80	Steel
L1008.030-AA-xxx	3	5	7,5	0,50	Steel
L1008.060-AA-xxx	6	12	14	0,80	Steel
L1008.090-AA-xxx	9	18	19,5	1,00	Steel
L1008.120-AA-xxx	12	22	25	1,20	Steel



Plastic cage (type PR)

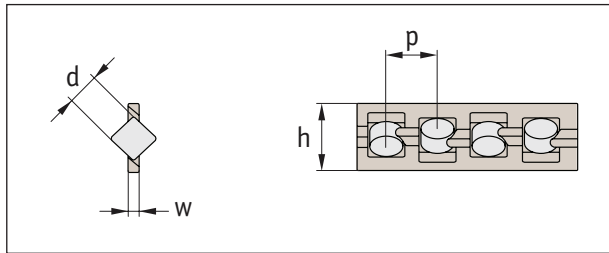

Steel cage (type AA)

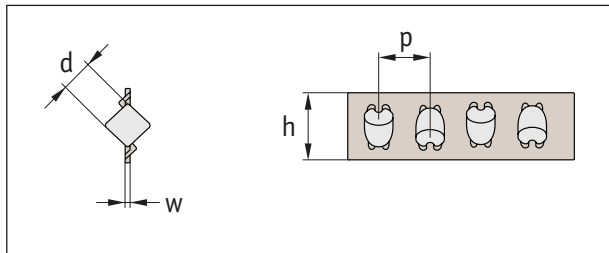

Roller load ratings (per roller)			
Rail size	Max. dynamic load C_0 N	Max. static load C N	Allowable* load N
1	125	144	48
2	290	290	95
3	630	760	250
4	1230	1170	390
6	2570	2630	870
9	7190	7270	2420
12	14700	13100	4300

The more rollers the greater the load capacity

* Allowable load is 1/3 of max. static load/roller, to allow a safety factor in calculations of 3.

End pieces

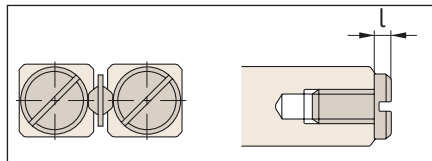

Type GA

- For horizontal applications, most used.

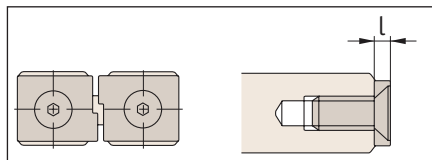

Type GB

- For horizontal or vertical applications.

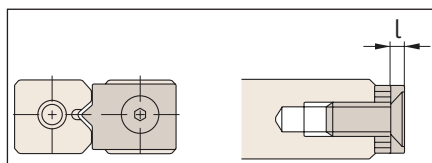

Type GC

- For horizontal or vertical applications.
- Mount on longer rail only.

Rail size	Type		
	GA l	GB l	GC l
1	1,5	-	-
2	2	3	-
3	2	2	3
6	3	3	5
9	3	4	6
12	3	5	8

End screws

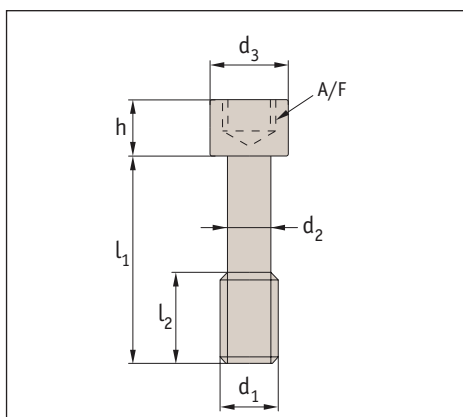

Rail	h	d ₁	d ₂	d ₃	l ₁	l ₂	A/F
3	3	M3	2,3	5	12	5	2,5
6	5	M5	3,9	8	20	8	4
9	6	M6	4,6	8,5	30	12	5
12	8	M8	6,25	11,3	40	17	6