



Stainless X Rail

T rail (master)



Long Linear Rails

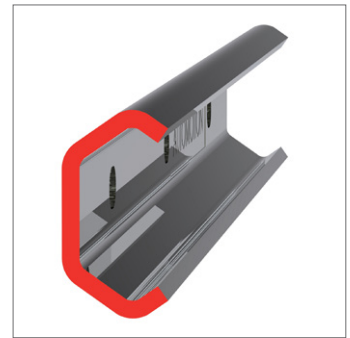
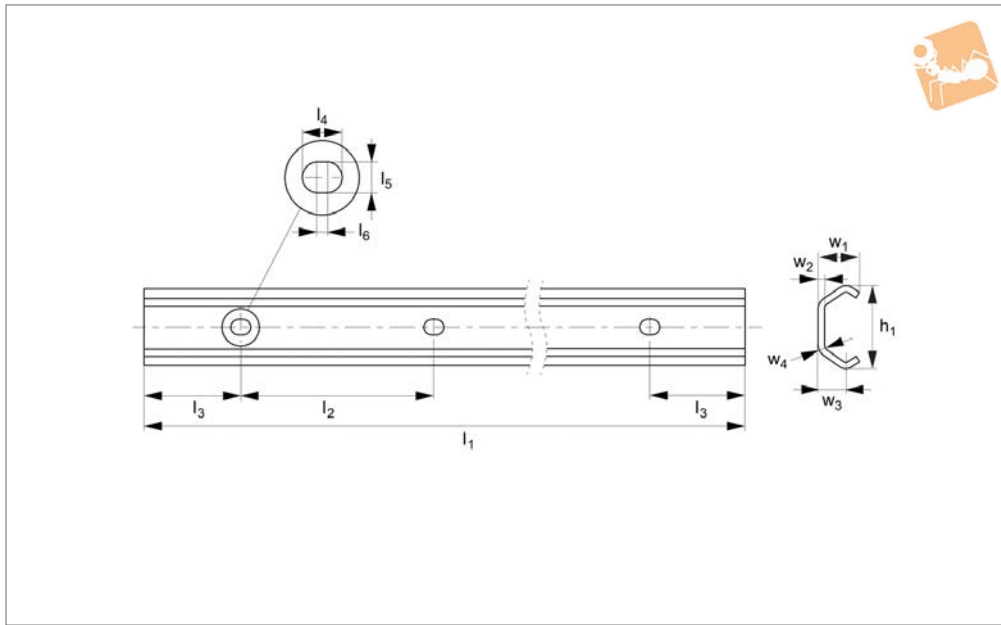

L1971.T

LONG LINEAR RAILS

Material

Stainless steel (316L). Corrosion resistant FDA/USDA compliant materials.

Technical Notes

X rail is for light duty loads, select number

of carriages to suit.

Tips

Use hex. socket oval head screws (ISO 7380), see part no. L1971.S.

Order No.	Rail size	l_1	h_1	l_2	l_3	l_4	l_5	l_6	w_1	w_2	w_3	w_4	For screw	Weight kg
L1971.20T-1040	20	1040	19.2	80	40	7	4.5	2.5	10.2	2.0	6.9	3.0	M 4	0.47
L1971.20T-2080	20	2080	19.2	80	40	7	4.5	2.5	10.2	2.0	6.9	3.0	M 4	0.47
L1971.20T-3120	20	3120	19.2	80	40	7	4.5	2.5	10.2	2.0	6.9	3.0	M 4	0.47
L1971.26T-1040	26	1040	26.1	80	40	11	6.0	5.0	14.0	2.5	9.5	4.5	M 4	0.80
L1971.26T-2080	26	2080	26.1	80	40	11	6.0	5.0	14.0	2.5	9.5	4.5	M 5	0.80
L1971.26T-3120	26	3120	26.1	80	40	11	6.0	5.0	14.0	2.5	9.5	4.5	M 5	0.80
L1971.30T-1040	30	1040	29.5	80	40	11	6.0	5.0	15.0	2.5	10.0	4.5	M 5	0.90
L1971.30T-2080	30	2080	29.5	80	40	11	6.0	5.0	15.0	2.5	10.0	4.5	M 5	0.90
L1971.30T-3120	30	3120	29.5	80	40	11	6.0	5.0	15.0	2.5	10.0	4.5	M 5	0.90
L1971.40T-1040	40	1040	39.5	80	40	13	9.0	4.0	20.0	3.0	13.0	6.0	M 8	1.55
L1971.40T-2080	40	2080	39.5	80	40	13	9.0	4.0	20.0	3.0	13.0	6.0	M 8	1.55
L1971.40T-3120	40	3120	39.5	80	40	13	9.0	4.0	20.0	3.0	13.0	6.0	M 8	1.55
L1971.45T-1040	45	1040	46.4	80	40	11	9.0	2.0	24.0	4.0	15.5	6.5	M 8	2.29
L1971.45T-2080	45	2080	46.4	80	40	11	9.0	2.0	24.0	4.0	15.5	6.5	M 8	2.29
L1971.45T-3120	45	3120	46.4	80	40	11	9.0	2.0	24.0	4.0	15.5	6.5	M 8	2.29



The X rail system is a highly cost-effective product made of zinc plated steel (L1970), the stainless steel version (L1971) has a high level of corrosion resistance.

Cost-effective and corrosion resistant

The X rail is relatively inexpensive as it is based on a rolled formed, steel section. It allows for adjustments due to misalignment of the structure that it is being used on and with internal raceways is suited for robust use but is not suitable for applications having significant moment loads.

The stainless steel (316L) version uses FDA and USDA compliant materials.

LONG LINEAR RAILS

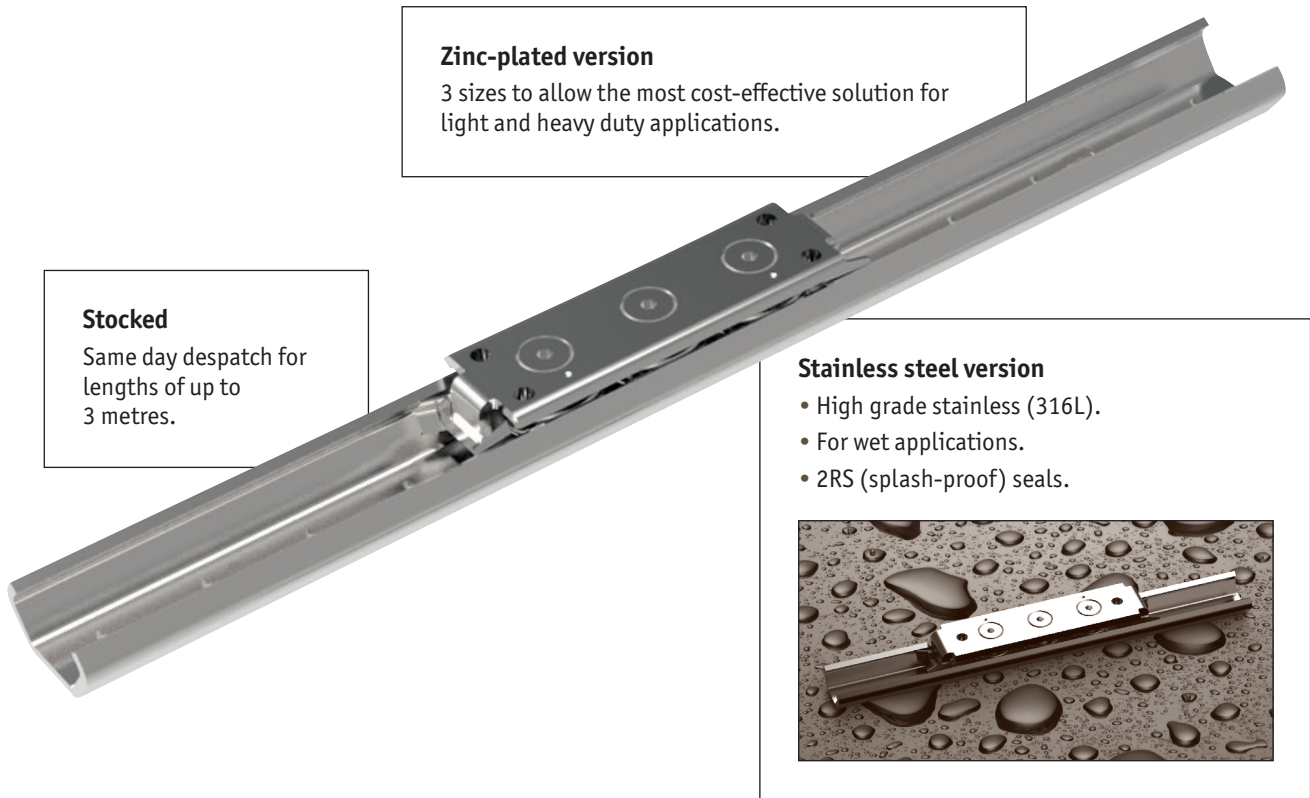

Zinc-plated version
3 sizes to allow the most cost-effective solution for light and heavy duty applications.

Stocked
Same day despatch for lengths of up to 3 metres.

Stainless steel version

- High grade stainless (316L).
- For wet applications.
- 2RS (splash-proof) seals.



Flexibility in set-up
X rail allows the sliders one rail to remain fixed in place but allows some lateral movement of the sliders in the other rail to adapt to any misalignment.

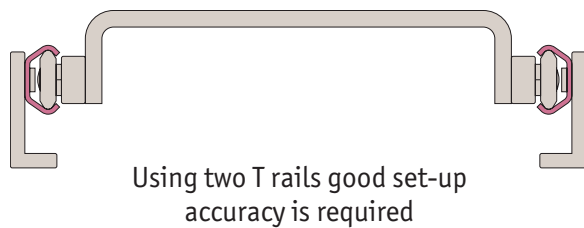
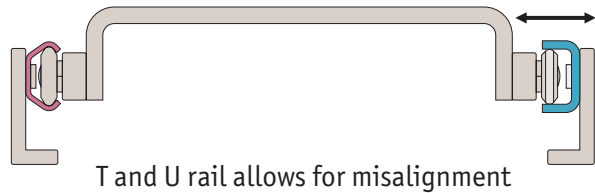

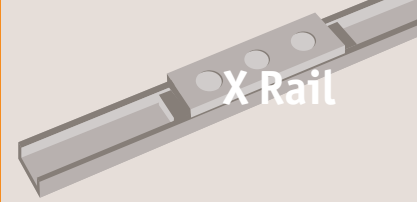

Specifications

- Maximum speed 1,5 m/s.
- Maximum acceleration 2 m/s².
- Maximum rail length 3120 mm.
- Three rail sizes 20, 30 and 45.
- Temperature range steel -30°C to +120°C.
- Temperature range stainless -30°C to +100°C.
- Sliders have two fixed rollers and one eccentric roller for adjustment of preload.
- Two slider body types; solid slider version and low profile slider version (T rails only).
- Joining of rails together, if required please discuss with our Technical Department.
- Not suitable for large moment loads (in this case use two or more sliders/rails to reduce moment loads).
- For applications with high moment and/or higher precision loads please use our Compact Rail System.

Applications



Safety guarding

Extending protective systems
sliding gates
automatic pick & place



Sliding doors & windows

Internal sliding doors
gates • roof lights
display cases



Medical technology

X-ray equipment
dental chairs
bed extensions



Food, drink & pharmaceuticals

Food handling conveyors
pharmaceutical factories
stainless display equipment



Transport (naval)

Sliding hatches
pull-out storage



Transport (rail)

Seat adjustment
sliding doors
battery removal units



Transport (automotive)

Ambulance sliding systems
fire fighting vehicles
sliding panels

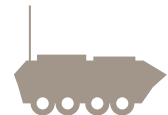

Transport (military)

Sliding seats
protective hatches
stretcher extensions



Water & waste

Sliding protective hatches
wash down applications
water tank doors



L1970 Zinc-plated steel version



Zinc-Plated Steel

Solid body slider



L1970.CEST/U
(2Z dust proof seals)

Low profile slider



L1970.CES
(2Z dust proof seals)



Zinc-Plated Steel

T Rail (master)

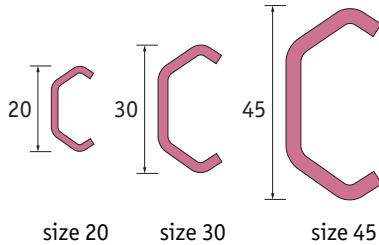

L1970.TES

U Rail (slave)

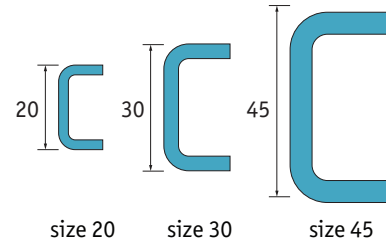

L1970.UES

L1971 Stainless Steel version



Stainless Steel

Solid body



L1971.CEXT/U
(2RS splash proof seals)

Low profile slider



L1971.CEX
(2RS splash proof seals)



Stainless Steel

T Rail (master)

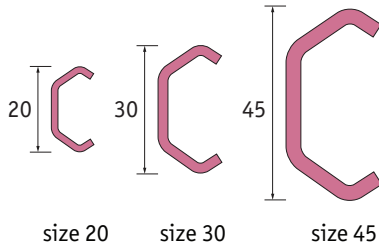

U Rail (slave)

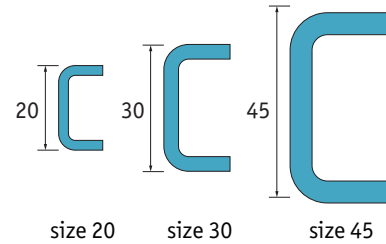

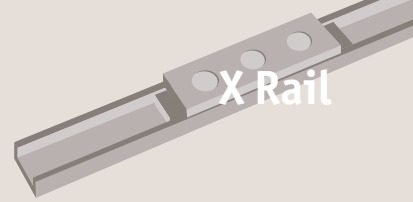

Two rail types

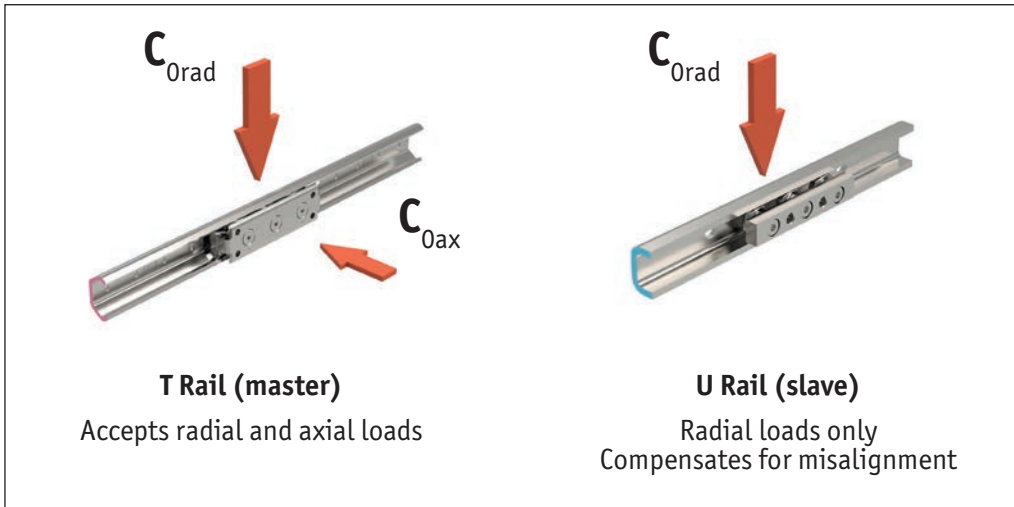

Selecting the correct rail

Firstly

The decision needs to be made if zinc plated steel or stainless steel rails and sliders are required.

- The zinc plated steel version (L1970) of the product is considerably less expensive than the 316L stainless steel type (L1971).
- The rollers in the zinc plated (L1970) sliders are protected by 2Z metal bearing covers. These are not meant to be used in anything other than a dry environment.
- The L1971 stainless steel X rail system is resistant to water and many chemicals. The slider rollers have rubber 2RS roller seals – being water resistant (not to be used fully submersed).

Secondly

The size of system to be used is selected.

- There are three different rail and slider sizes: 20, 30 and 45.
- The load that is being carried and its shape needs to be considered. The X rail system is not really suited for moment loads. If moment loads exist then two or more rails/sliders should be used to offset this. Typically 2, 4 or more sliders are used and the load carried should be divided over the number of sliders bearing in mind that if using a U rail slider along with a T rail, the U rail sliders do not have any axial load capacity.
- The rails are supplied in standard lengths of 1040mm, 2080mm and 3120mm – and can easily be cut to other required lengths by Automotion (on request).

Finally

Decide whether a low profile slider or a solid body slider is required (low profile sliders are only available for T rails). The low profile (L1970.CES and L1971.CEX) sliders are less expensive than the solid body sliders.

Please note

It is very important to ensure that the correct low profile fixing screws are used with this rail (see part no. L1970.S for zinc plated steel and L1971.S for stainless steel). Using other higher profile heads may lead to contact between the underside of the slider and the top of the screws.

X Rail from Automotion Components

LONG LINEAR RAILS