

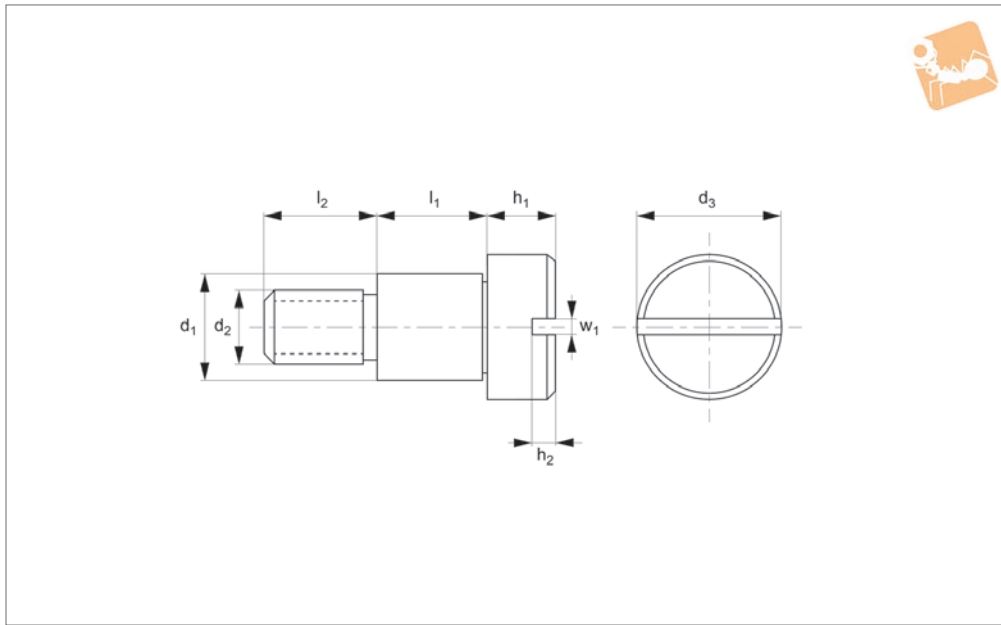

Shoulder Screws - Slot Head

slot drive - 416 stainless

Shoulder Screws



P0133

SHOULDER SCREWS

Material

Stainless steel (AISI 416, 1.4005). Tensile strength 650 N/mm². Proof stress min. 450 N/mm², martensitic stainless steel.

Technical Notes

Stainless steel 416 is a harder, stronger

grade of stainless steel than the 303 stainless alternatives.

They are magnetic and slightly less resistant to corrosion than the 303 alternative (see P0130 or P0132).

For corrosion resistance it is suited to dry

atmosphere, fresh water and mild alkalis and acids.

Special lengths and diameters produced to drawings.

Order No.	d ₁ +0 -0.025	l ₁ +0.05 -0.0	d ₂	d ₃	l ₂	h ₁	h ₂	w ₁
P0133.040-004-A6	4	4	M 3	6	4	3	0.3	0.4
P0133.040-005-A6	4	5	M 3	6	4	3	0.3	0.4
P0133.040-006-A6	4	6	M 3	6	4	3	0.3	0.4
P0133.040-008-A6	4	8	M 3	6	4	3	0.3	0.4
P0133.040-010-A6	4	10	M 3	6	4	3	0.3	0.4
P0133.050-004-A6	5	4	M 4	8	5	4	0.9	0.8
P0133.050-005-A6	5	5	M 4	8	5	4	0.9	0.8
P0133.050-006-A6	5	6	M 4	8	5	4	0.9	0.8
P0133.050-008-A6	5	8	M 4	8	5	4	0.9	0.8
P0133.050-010-A6	5	10	M 4	8	5	4	0.9	0.8
P0133.050-012-A6	5	12	M 4	8	5	4	0.9	0.8
P0133.050-014-A6	5	14	M 4	8	5	4	0.9	0.8
P0133.050-016-A6	5	16	M 4	8	5	4	0.9	0.8
P0133.050-020-A6	5	20	M 4	8	5	4	0.9	0.8
P0133.050-030-A6	5	30	M 4	8	5	4	0.9	0.8
P0133.060-004-A6	6	4	M 5	10	6	5	1.2	1.0
P0133.060-005-A6	6	5	M 5	10	6	5	1.2	1.0
P0133.060-006-A6	6	6	M 5	10	6	5	1.2	1.0
P0133.060-008-A6	6	8	M 5	10	6	5	1.2	1.0
P0133.060-010-A6	6	10	M 5	10	6	5	1.2	1.0
P0133.060-014-A6	6	14	M 5	10	6	5	1.2	1.0
P0133.060-016-A6	6	16	M 5	10	6	5	1.2	1.0
P0133.060-020-A6	6	20	M 5	10	6	5	1.2	1.0
P0133.060-025-A6	6	25	M 5	10	6	5	1.2	1.0
P0133.060-030-A6	6	30	M 5	10	6	5	1.2	1.0
P0133.080-006-A6	8	6	M 6	12	11	6	1.3	1.2
P0133.080-008-A6	8	8	M 6	12	11	6	1.3	1.2
P0133.080-010-A6	8	10	M 6	12	11	6	1.3	1.2
P0133.080-012-A6	8	12	M 6	12	11	6	1.3	1.2
P0133.080-016-A6	8	16	M 6	12	11	6	1.3	1.2
P0133.100-008-M6	10	8	M 6	12	11	6	1.5	1.6

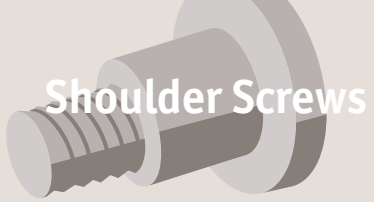

Shoulder Screws

Shoulder Screws - Slot Head slot drive - 416 stainless



SHOULDER SCREWS

Order No.	d ₁ +0 -0.025	l ₁ +0.05 -0.0	d ₂	d ₃	l ₂	h ₁	h ₂	w ₁
P0133.100-012-M6	10	12	M 6	12	11	6	1.5	1.6
P0133.100-016-M6	10	16	M 6	12	11	6	1.5	1.6
P0133.101-008-M8	10	8	M 8	14	12	7	1.9	2.0
P0133.101-012-M8	10	12	M 8	14	12	7	1.9	2.0
P0133.101-016-M8	10	16	M 8	14	12	7	1.9	2.0
P0133.120-012-A6	12	12	M10	20	16	8	2.4	2.5
P0133.120-016-A6	12	16	M10	20	16	8	2.4	2.5
P0133.120-025-A6	12	26	M10	20	16	8	2.4	2.5

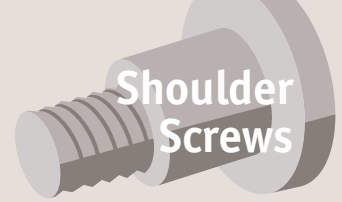

Steel shoulder screws

These are our least expensive option. They are produced to ISO 7379 standards.

Thread sizes from Ø4 M3 to Ø24 M20. We manufacture special shoulder screws to customer drawings with a minimum batch size.



Stainless steel shoulder screws

We have three different grades of stainless steel shoulder screws:

303 series – these are our standard grade of stainless (P0130.A2). They are strong and resistant to corrosion but not to very harsh environments such as salt water.





416 series – these are made from harder stainless steel with improved shear strengths but the parts are more prone to corrosion (see part no. P0131 and P0133).

316 series – these shoulder screws (P0130.A4) are very resistant to corrosion but are considerably more expensive than other stainless versions.

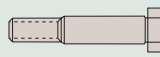

Shoulder bolts

Our range of precision shoulder bolts with hexagonal heads come in both steel (grades 8.8 and 10.9) and stainless steel (303 and 316 stainless). These bolts are manufactured to DIN 609 and DIN 610. We also have shoulder bolts for construction, manufactured to DIN 7968.

	DIN 609 standard length thread	DIN 610 short length thread	DIN 7968 construction thread
Grade 8.8 steel 	 P0138.SC	 P0140.SC	 P0142
Grade 10.9 steel 	P0139	P0141	-
303 stainless steel 	P0138.A2	P0140.A2	-