

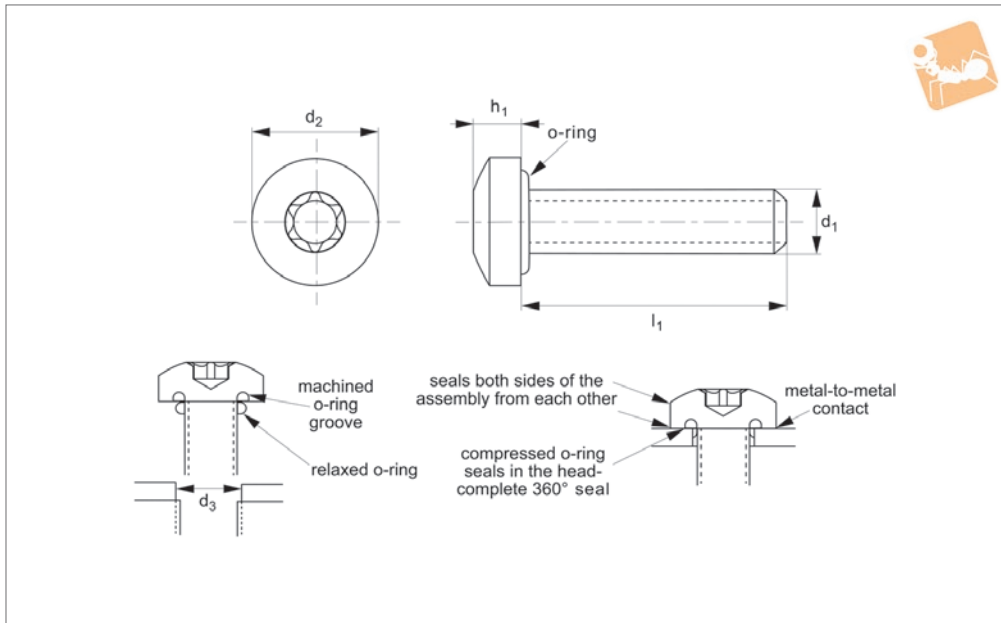

Pan Head Seal Screws torx drive

Sealing Screws and Plugs



P0172

SEALING SCREWS AND PLUGS

Material

Stainless steel (AISI 303 1.4305 tensile strength 550 N/mm²), with silicone „O“ ring as standard.

For other „O“ ring materials see technical data pages (-FS = fluorosilicone, -EP = EPDM, -VI = viton, -NI = nitrile, -BN = Buna etc.).

Other thread lengths, and stainless steel

A4 (AISI 316) on request.

Technical Notes

Seals substances in and contaminants out. Screws generally as DIN 7985 H, ISO 7045. Re-useable.

Max temperature range: -100°C to +260°C. Pressure range - up to 410 bar (6000 psi). Also available (on request) with thread-

locking.

Tips

Clearance holes recommended for maximum sealing performance (see dimensions below).

Clearance hole depth 2-3 x thread pitch. Threads are metric coarse pitch.

Order No.	d ₁	l ₁	h ₁ max.	d ₂ max.	d ₃ ±0.05	Drive
P0172.030-006-SI	M 3	6	2.4	6.0	3.6	TX-10
P0172.030-008-SI	M 3	8	2.4	6.0	3.6	TX-10
P0172.030-010-SI	M 3	10	2.4	6.0	3.6	TX-10
P0172.030-012-SI	M 3	12	2.4	6.0	3.6	TX-10
P0172.030-020-SI	M 3	20	2.4	6.0	3.6	TX-10
P0172.040-006-SI	M 4	6	3.3	8.0	4.5	TX-20
P0172.040-008-SI	M 4	8	3.3	8.0	4.5	TX-20
P0172.040-010-SI	M 4	10	3.3	8.0	4.5	TX-20
P0172.040-012-SI	M 4	12	3.3	8.0	4.5	TX-20
P0172.040-016-SI	M 4	16	3.3	8.0	4.5	TX-20
P0172.040-020-SI	M 4	20	3.3	8.0	4.5	TX-20
P0172.050-008-SI	M 5	8	3.7	10.0	5.6	TX-25
P0172.050-010-SI	M 5	10	3.7	10.0	5.6	TX-25
P0172.050-012-SI	M 5	12	3.7	10.0	5.6	TX-25
P0172.050-016-SI	M 5	16	3.7	10.0	5.6	TX-25
P0172.050-020-SI	M 5	20	1.6	10.0	5.6	TX-25
P0172.060-012-SI	M 6	12	4.6	12.0	6.8	TX-30
P0172.060-016-SI	M 6	16	4.6	12.0	6.8	TX-30
P0172.060-020-SI	M 6	20	4.6	12.0	6.8	TX-30
P0172.060-025-SI	M 6	25	4.6	12.0	6.8	TX-30
P0172.060-030-SI	M 6	30	4.6	12.0	6.8	TX-30
P0172.080-012-SI	M 8	12	6.0	16.0	8.5	TX-40
P0172.080-016-SI	M 8	16	6.0	16.0	8.5	TX-40
P0172.080-020-SI	M 8	20	6.0	16.0	8.5	TX-40
P0172.080-025-SI	M 8	25	6.0	16.0	8.5	TX-40
P0172.080-030-SI	M 8	30	6.0	16.0	8.5	TX-40
P0172.030-006-VI	M 3	6	2.4	6.0	3.6	TX-10
P0172.030-008-VI	M 3	8	2.4	6.0	3.6	TX-10



Order No.	d ₁	l ₁	h ₁ max.	d ₂ max.	d ₃ ±0.05	Drive
P0172.030-010-VI	M 3	10	2.4	6.0	3.6	TX-10
P0172.030-012-VI	M 3	12	2.4	6.0	3.6	TX-10
P0172.030-020-VI	M 3	20	2.4	6.0	3.6	TX-10
P0172.040-006-VI	M 4	6	3.3	8.0	4.5	TX-20
P0172.040-008-VI	M 4	8	3.3	8.0	4.5	TX-20
P0172.040-010-VI	M 4	10	3.3	8.0	4.5	TX-20
P0172.040-012-VI	M 4	12	3.3	8.0	4.5	TX-20
P0172.040-016-VI	M 4	16	3.3	8.0	4.5	TX-20
P0172.040-020-VI	M 4	20	3.3	8.0	4.5	TX-20
P0172.050-008-VI	M 5	8	3.7	10.0	5.6	TX-25
P0172.050-010-VI	M 5	10	3.7	10.0	5.6	TX-25
P0172.050-012-VI	M 5	12	3.7	10.0	5.6	TX-25
P0172.050-016-VI	M 5	16	3.7	10.0	5.6	TX-25
P0172.050-020-VI	M 5	20	1.6	10.0	5.6	TX-25
P0172.060-012-VI	M 6	12	4.6	12.0	6.8	TX-30
P0172.060-016-VI	M 6	16	4.6	12.0	6.8	TX-30
P0172.060-020-VI	M 6	20	4.6	12.0	6.8	TX-30
P0172.060-025-VI	M 6	25	4.6	12.0	6.8	TX-30
P0172.060-030-VI	M 6	30	4.6	12.0	6.8	TX-30
P0172.080-012-VI	M 8	12	6.0	16.0	8.5	TX-40
P0172.080-016-VI	M 8	16	6.0	16.0	8.5	TX-40
P0172.080-020-VI	M 8	20	6.0	16.0	8.5	TX-40
P0172.080-025-VI	M 8	25	6.0	16.0	8.5	TX-40
P0172.080-030-VI	M 8	30	6.0	16.0	8.5	TX-40

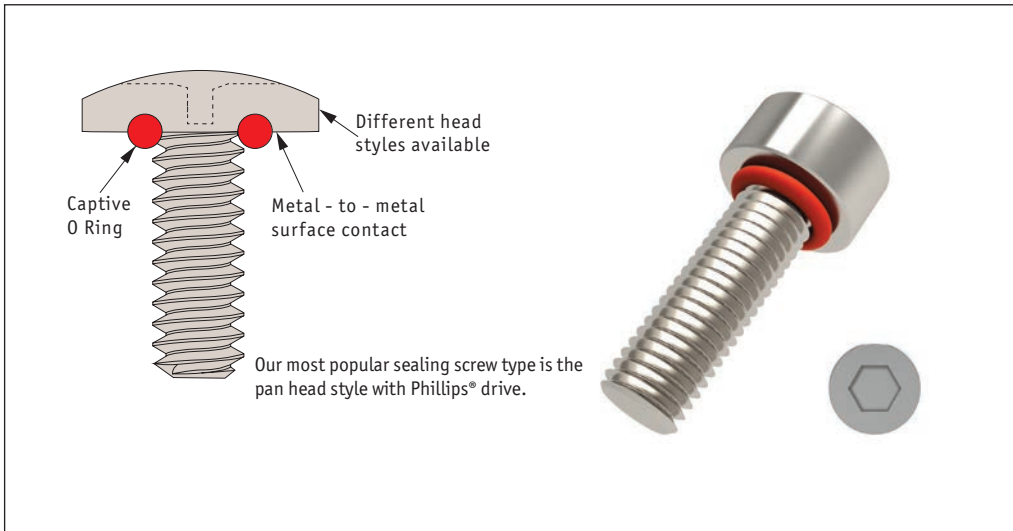

An ordinary screw lacks seal protection, allowing dirt, fluids, gases etc to infiltrate and damage sensitive devices. Sealing screws provide bi-directional sealing protection to systems where screws are used to protect them against dirt, chemicals, water or other contaminants, which (without the screw seal), may penetrate and damage, or alternatively where gases and liquids may leak out.

The seal screws incorporate an O ring underneath the screw, bolt etc which forms a sealant layer. The seal provides bi-directional sealing. The screws are very easy to use and do not need any special preparation or re-tightening.

Integral seal fasteners are designed and manufactured with a precision engineered groove beneath the head of the fastener. As the fastener is tightened, the O-ring is compressed, squeezing the O-ring between the groove and mating surface to complete the seal. The design of the groove controls the amount of compression of the O-ring. And because O-rings retain their elastic memory, the screws are reusable time after time.

There are a range of O ring materials that can resist virtually all chemical and environmental conditions. We can also provide sealing screws (on request) to military specifications (MILSPEC).

The screws are widely used in military, medical and industrial devices. Each screw is equipped with a captive O ring which provides a total barrier seal against internal or external conditions (water, fluids, chemicals, dirt, air, contaminants etc) which could otherwise penetrate and damage systems.

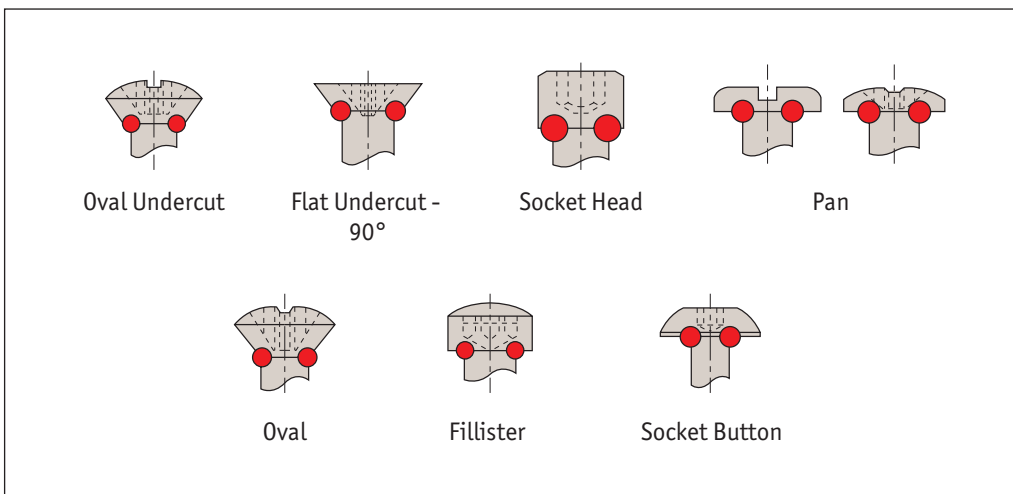

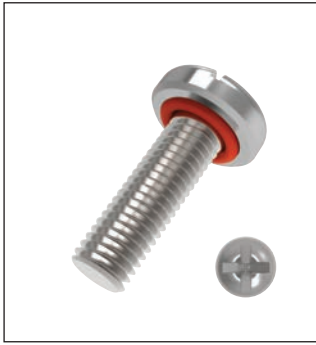

P0170
Pan Head - Phillips[®]
Security and Torx[®] Options

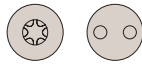

P0171
Pan Head - slotted



P0173
Socket Head
Security and Torx[®] Options

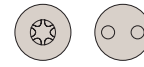

P0174
Button Hex-head
Security and Torx[®] Options

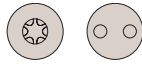

P0175
Countersunk Hex-head
Security and Torx[®] Options

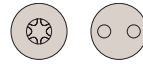

P0176
Hexagon Head Bolt



P0177
Flanged Hexagon Nut



P0178
Hexagon Nut



P0179
Domed Nut

Sealing Screws from Automation Components

SEALING SCREWS AND PLUGS



Technical Information



Drive Types and O Ring Selection

Sealing Screws

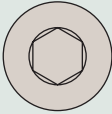

SEALING SCREWS AND PLUGS

Sealing Screws from Automation Components

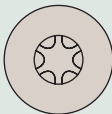
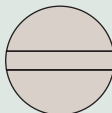
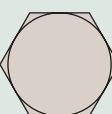
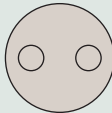
Schematic	Drive Types	Uses
	Hexagonal Socket	Ideal for precision assembly. Most recommended where less surface area is available.
	Cross Drive (Phillips®)	Provides good control in driving. Always use a driver bit of the proper size which is in good condition.
	Hexalobular (Torx®)	Positive-engaging, fast-locating method which transmits drive torque with less required downward pressure. Good fastening appearance.
	Slotted	Accepts standard blade screwdriver. Requires less downward pressure to drive parts than those with recessed openings. Use proper fitting blade to minimize slippage.
	Hex flange	Accepts hex wrench. Slotted drive is added to make it easier to remove the fastener (if required).
	Security	These screws are impossible to remove without the special matching screwdriver.

We can provide Torx® heads and security/tamper-proof screws, as well as special threads, grooves and cross holes for safety wires, and a further range of styles such as captive screws, anti-vibration strips on the threads etc (for extreme vibration applications).

O Ring Selection

Standard O rings are red silicone, but a further five O ring material types are readily available. The main factor to consider when selection an O ring type is the environment in which it will be placed, and the temperature range it will be subjected to.

Material	Notes
Silicone (SI)	Our standard O ring type with a wide temperature range -60°C to +200°C. Resistant to moderate or oxidising chemical, but not generally oil or solvent resistant.
Fluorosilicone (FS)	Widely used in the automotive and aerospace industries as it has excellent resistance to fuel, oil and solvents. Standard temperature range -50°C to +170°C.
EPDM (EP)	These O rings are very suited for outdoor environments and are good for weather and water resistance applications having excellent ozone, steam and chemical resistance. Temperature range -50°C to +110°C.
Viton-fluorocarbon (VI)	These seals are widely used on aircraft engines and automotive fuel handling systems as they have excellent fuel, oil and solvent resistance. Standard temperature range -50°C to +200°C
Nitrile (NI)	Widely used as highly resistant to petroleum based substances, water and alcohols. Temperature range -50°C to +110°C.

Other O rings types can include Neoprene, Buna N, Teflon etc.

ov-sealing-screws-drive-types-o-rings-rnh-Updated-10-02-2023



Our standard screw material is stainless steel (A2). Other materials available are aluminium (non-magnetic and 1/8 weight of steel), brass (high electrical conductivity, non-magnetic and good corrosion resistance), titanium (low weight, very strong and highly corrosion resistant), stainless steel (A4, AISI 316).

Fasteners can be supplied to MILSPEC standards (MIL-S-82496A) on request.

Finishes

Finishes are dependent on the material you are wishing to coat, but include:

Finish	Notes
Black Chrome (MIL-C-1458B)	Black chrome is a hard, non-reflective coating which is resistant to abrasion, heat and erosion. The black chrome surface is a dull, dark grey and may be waxed or oiled to darken surface.
Black Oxide Coating (MIL-C-13924B)	Black oxide is a uniform black coating for ferrous metals. Generally it is considered a decorative coating and provides only very limited corrosion protection under mild corrosion conditions.
Cadmium	Cadmium is a bright, silvery white plating. Supplementary treatments for Type II can be golden, iridescent, amber, black or olive drab.
Passivate (QQ-P-35/MIL S-5005C)	Passivation is a process designed to remove foreign metals from the surface of stainless and corrosion resistant steels.
Phosphate Coating Light (TT-C-00490B)	Phosphate coating is a light coating for use as a base paint.
Gold (MIL-G-45204B)	Yellow to orange colour depending on proprietary process used. Will range from matt to bright finish depending on base metal. Good corrosion resistance and high tarnish resistance.
Nickel (QQ-N-290A)	Nickel is a corrosion protective plating for steel, zinc and zinc alloys as well as copper and copper alloys.
Zinc (QQ-Z-325C)	The primary use of chromate finishes on zinc is to retard or prevent formation of white corrosion products on zinc surfaces.



Shoulder Screws

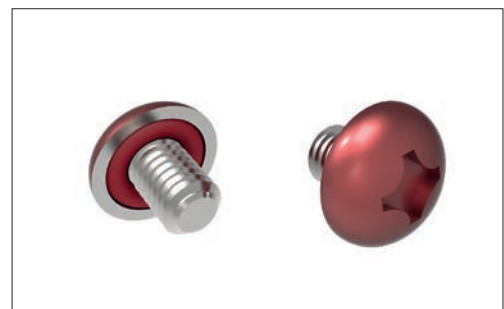

Painted Heads



Captive Screws



Security Heads (Tamper Proof)

Sealing Screws from Automation Components

SEALING SCREWS AND PLUGS